

High Definition Digital Video Camera

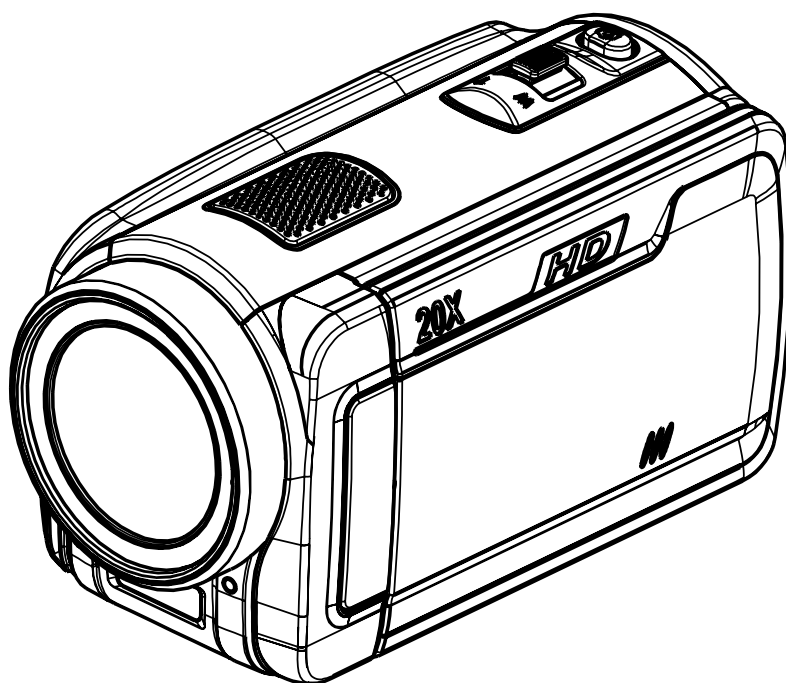

User's Manual

Contents

Section 1	Getting to Know Your Camera.....	3
Section 2	Getting Started.....	6
Section 3	Enjoying the Record Mode	8
Section 4	Enjoying the Playback Mode	18
Section 5	Setting Your Camera	24
Section 6	Viewing Pictures and Movies on a TV	28
Section 7	Viewing Movie & Picture on PC.....	29
Section 8	Burning the Recorded Clip into DVD.....	30
Section 9	Uploading Video Files to YouTube.....	32
Section 10	Specifications and System Requirements	36
Section 11	Troubleshooting.....	38

Section 1

Getting to Know Your Camera

Overview

The camera with 5 Mega Pixel sensor can take H.264 movies. By way of using H.264 technology, more videos can be taken within certain amount of memory. High quality images with up to 12 mega-pixels can also be delivered smoothly. With a color LCD monitor, users can compose images and examine them easily.

The camera features 3" LCD touch panel which is an ideal platform for you to operate your camera. The menu options are accessible with your finger. With the touch panel, you can select the options directly and quickly.

The camera also features movie recording at HD resolution of 1920x1080. You can also connect it to an HDTV via HDMI cable, and easily playback recorded high-definition videos on the wide screen HDTV.

Moreover, the camera has an advanced uploading feature. With the exclusive built-in **YouTube Direct** application, you can upload the videos captured by the camera to YouTube more effortlessly .

ISO sensitivity and color balance can either be adjusted automatically or allowed to be changed manually. A 5x optical zoom increases you control over the movies and pictures you take.

Built-in memory allows you to take pictures and movies without memory card. The memory card slot allows users to increase the storage capacity.



Note

Partial memory of the built-in memory is used for Firmware code.

Standard Accessories

Unpack the package and make sure all standard accessories listed are included:

- Camera
- USB Cable
- AV Cable
- HDMI Cable
- Adaptor
- Lithium-ion Rechargeable Battery
- Quick Guide
- CD-ROM (Software and User's Manual)

Front View

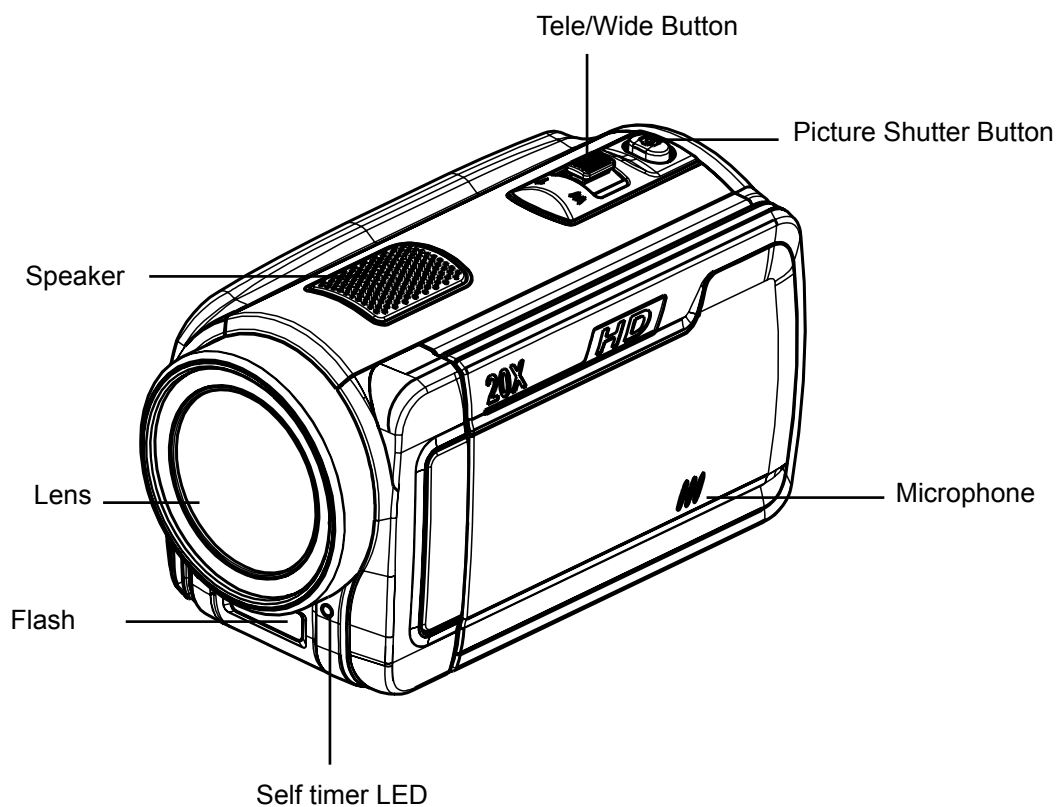

Rear View

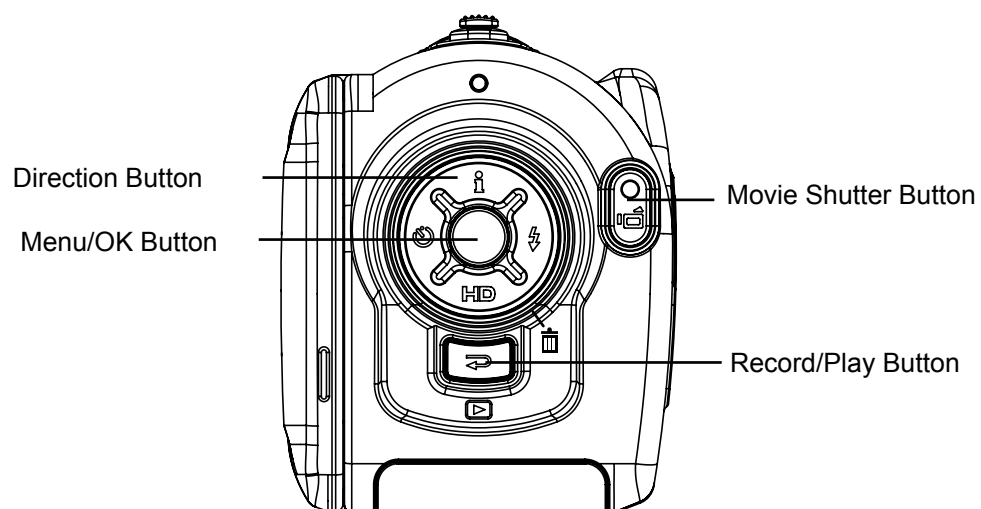

Side View

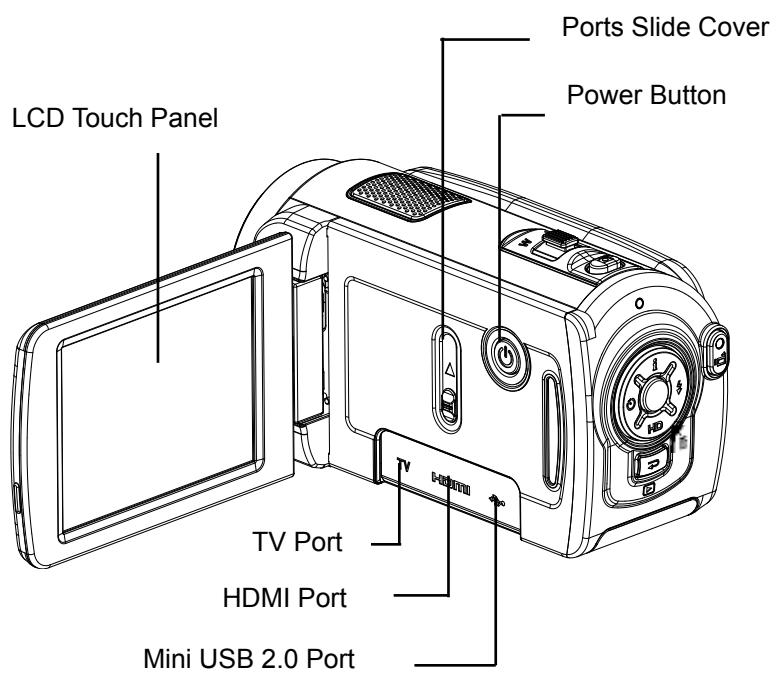

Bottom View

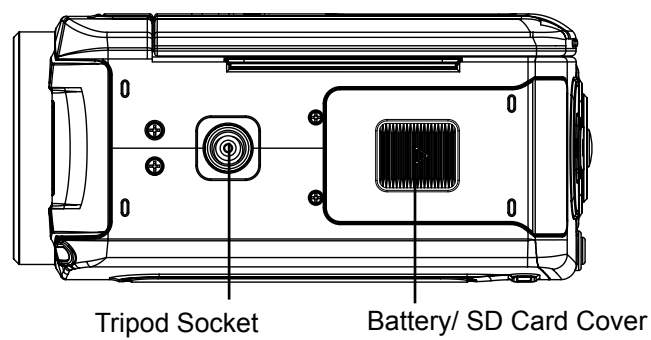

Section 2 Getting Started

Loading the Battery

Before using the camera, users must load Lithium-ion rechargeable battery

1. Insert the battery following to the correct polarity marks (+ or -).
2. Close the battery cover firmly.

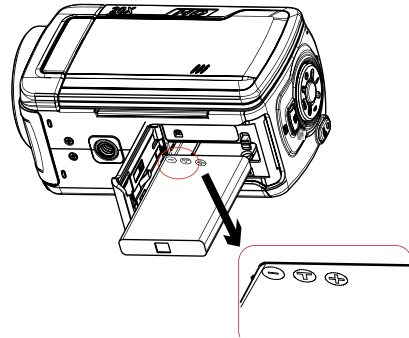

Inserting and Removing an SD Card (Optional)

The camera comes with internal memory which allows you to store pictures and movies. You can expand the memory capacity by using an optional SD/SDHC memory card.

1. Insert the memory card into the right position. Please refer to the figure.
2. To remove an installed SD card, press the card inwards to release it.
3. When the card pops out, gently remove it from its slot.
4. Recommended memory capacity: 1GB above.

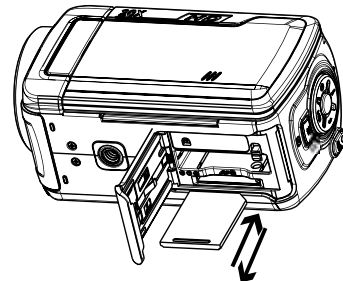

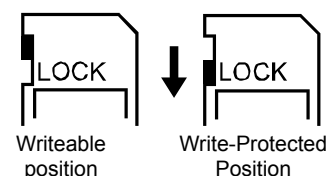

Note

- When a memory card is fitted, movies/pictures are saved on card rather than on the built-in memory.
- *Protecting Data on an SD Card: SD card is read-only by locking the SD card. No pictures and movies can be recorded when the SD card is locked. Make sure the lock is on writeable position before recording any media.*



Turning the Camera On and Getting Started

- To turn on the camera:
 1. Flip out the LCD panel; the camera will turn on automatically.
 2. Or press Power Button for one second to turn on it.
- To take a movie: Press the Movie Shutter Button ().
- To take a picture: Press the Picture Shutter Button () halfway down till the focusing frame turns from white to green. Then, press the Picture Shutter Button fully down to take picture.

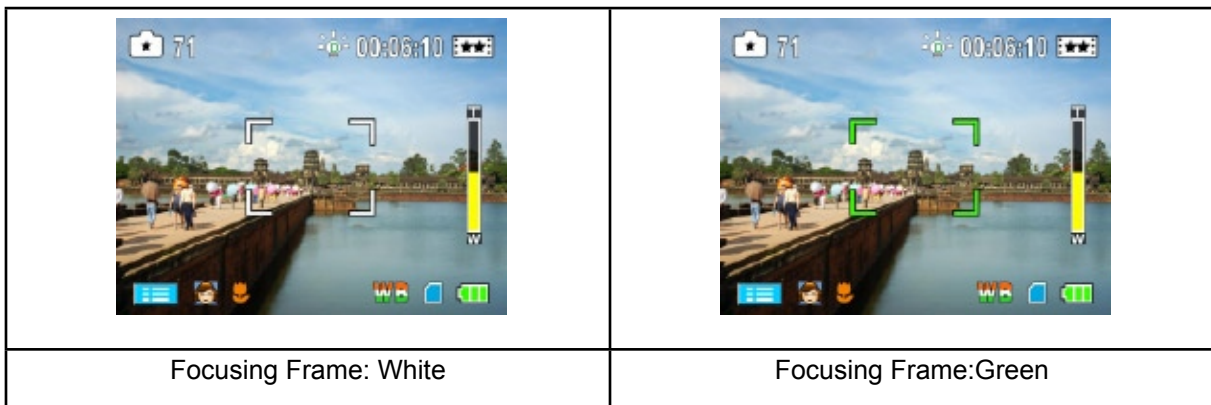

- To view stored movies and pictures, press Record/Play Button () once to switch to Playback Mode. Press a second time to return to Record Mode.





Turning the Camera Off

- To turn off the camera: You can either press the Power Button for one second, or you can place the LCD panel back to its original position.

Section 3

Enjoying the Record Mode

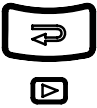











Button Function













	<p>Direction Button</p> <p>Right Button: Flash Auto/Red-Eye-Reduction/Digital Light/Flash OFF</p> <p>Left Button: Self timer ON/OFF</p> <p>Up Button: LCD Information ON/OFF</p> <p>Down Button: HD(1080p)/VGA mode switch</p> <p>Menu/OK Button: Menu On. Validate the setting.</p> <p>Tele Button : Zoom In</p> <p>Wide Button : Zoom out</p>
	<p>Power Button: Press down for one second to turn on or turn off the camera</p>
	<p>RECORD/PLAY Button functions:</p> <ol style="list-style-type: none"> 1. Switch between Record /Playback Mode 2. Return to the previous page 3. For quick review, press it after recording
	<p>Movie Shutter Button:</p> <ol style="list-style-type: none"> 1. Start to take movie. 2. To stop recording, press it again.
	<p>Picture Shutter Button: Start to take picture.</p>

LCD Monitor Information

The indicators shown below may display on LCD when movies and pictures are recorded:



(1)	Movie Resolution	
		HD (1080p) (30fps)
		HD (720p) (30fps)
		WVGA (60fps)
		VGA (30fps)
		QVGA (30fps)
	Picture Resolution	
		High
		Standard
	Low	
(2)	71	Number of images that can still be taken at current resolution
	00:06:10	Recording time of movie that can still be taken at current resolution
(3)		Flash Auto
		Red Eye Reduction
		Digital light On
		Flash Off
(4)		Self-timer enabled



(5)		Motion Detection
(6)		Option menu On
(7)	Scene	
		Skin
		Night
		Backlight
(8)		Macro Position Focusing
(9)	WB	Manual White Balance
(10)		SD Card inserted
(11)		Battery: full power
		Battery: medium power
		Battery: low power
		Battery: power empty
(12)		Zoom meter: HD(1080p):1X~5X (5X Optical zoom and 1X Digital zoom) Other video resolution:1X~20X (5X Optical zoom and 4X Digital zoom)
(13)		Stabilization







Note

Scene: B/W / Classic / Negative effect can be previewed immediately without indicator on the LCD

Movie Recording

- Press Movie Shutter Button () to start recording. When a movie is recording, a time indicator will display on LCD monitor. To stop recording, press Movie Shutter Button () again.
- Press RECORD/PLAY Button to view the recorded movie.
- Five resolution settings are available:

Video Quality	
	HD (1080p) (30fps)
	HD (720p) (30fps)
	WVGA (60fps)
	VGA (30fps)
	QVGA (30fps)

Picture Recording









- Press the Picture Shutter Button () halfway down till the focusing frame turns from white to green. Then, press the Picture Shutter Button fully down to take picture.
- Press RECORD/PLAY Button to view the picture.
- Three resolution settings are available:

Image Quality	
	High Quality: 12 Mega Pixels
	Standard Quality: 5 Mega Pixels
	Low Quality: 3 Mega Pixels

Using Flash or Digital Light Function



- This camera has three flash settings and one setting to allow you to extend the brightness of the objects that is dark or in the shadow. To change settings by Right Button.
 1. **Flash Auto** (): The flash fires automatically according to light conditions. Use this mode for general photography. (Picture recording only)
 2. **Red Eye Reduction**(): The pre-flash will fire to reduce the red-eye effect. (Picture recording only)
 3. **Digital Light** (): To extend dynamic range for backlight and high contrast sense so that the objects will be brighter and clearer.
 4. **Flash Off** (): The flash will not fire under any circumstances. Use this mode when taking images in a place where flash photography is prohibited, or when the subject is distant (beyond the range of the flash). (Picture recording only)



Note

The flash will be disabled automatically when battery power is low ().

Using Self-timer for taking pictures

- To use Self-timer:
 1. Press Left Button, the Self-timer icon() will appear on the screen.
 2. Press Picture Shutter Button() to take the picture, the self-timer light on the front of the camera blinks until the shutter operates (about 10 second later). The speed of blinking will increase just before the picture is taken.





Using Zoom Function

- The zoom magnifies images when recording movies or taking pictures.
 1. To zoom in/out, press the Tele/Wide Button.
 2. It can be set from 1X~5X (5X Optical zoom and 1X Digital zoom)/1X~20X (5X Optical zoom and 4X Digital zoom).



Options for Record Menu

Movie Mode	Picture Mode	Effect
<ul style="list-style-type: none"> • Resolution • Stabilization • Motion Detect 	<ul style="list-style-type: none"> • Resolution 	<ul style="list-style-type: none"> • Macro Mode • Scene • WB (White Balance) • ISO



Operations for Record Mode

Operation	Screen
<p>1. Touch  (on-screen icon) when in Record Mode. The Record menu will show on the screen.</p>	
<p>2. Touch the option icons on the screen lightly with your finger to move between main menu options, which are Movie Mode, Picture Mode, and Effect.</p> <p>3. Submenu will pop out while move to each main menu option.</p> <p>4. Touch to select the specific option you want to adjust, then touch OK icon to validate the setting. After validating the settings, touch exit icon () to back to Record mode.</p> <p>5. Or touch exit icon () to exit to Record mode without any change.</p>	



Movie Mode Submenu Setting

Operation	Display Screen
<ol style="list-style-type: none"> 1. In Record Mode, touch  (on-screen icon) to enter record menu screen. 2. Touch [Movie Mode] icon on the screen. Submenu of Movie Mode will pop out on the screen. 3. The Movie Mode submenu contains 3 options-- Resolution, Stabilization, and Motion Detect--for you to adjust the camera setting. 	

Movie Resolution

Operation	Display Screen
<ol style="list-style-type: none"> 1. In Movie Mode submenu, touch [Resolution] on the screen. 2. Touch  on the screen to move between five settings. 3. Touch OK icon to validate the setting then touch exit icon () to back to Record mode. 	

Stabilization



Operation	Display Screen
<ol style="list-style-type: none"> 1. In Movie Mode submenu, touch [Stabilization] on the screen. 2. Touch  on the screen to choose On or Off. 3. Touch OK icon to validate the setting then touch exit icon () to back to Record mode. 	





Note

Stabilization doesn't support HD(1080p) and WVGA(60fps).



Motion Detection

Operation	Display Screen
<ol style="list-style-type: none">1. In Movie Mode submenu, touch [Motion Detect] on the screen.2. Touch  on the screen to choose On or Off.3. Touch OK icon to validate the setting then touch exit icon () to back to Record mode.4. Camera will start to record video automatically if it detects a movement. Stop recording if it does not detect a movement.	 <p>The screenshot shows a camera settings menu with a blue background. At the top, there are four icons: a camera, a camera with a play button, a camera with a globe, and a camera with a wrench. Below these are three settings: 'Resolution' set to 'HD(720p)', 'Stabilization' set to 'Off', and 'Motion Detect' set to 'Off'. At the bottom, there are two buttons: 'OK' and a back arrow icon.</p>



Picture Mode Submenu Setting

Operation	Display Screen
<ol style="list-style-type: none"> In Record Mode, touch  (on-screen icon) to enter record menu screen. Touch [Picture Mode] icon on the screen. Submenu of Picture Mode will pop out on the screen. The Picture Mode submenu contains 1 option, Resolution, for you to adjust the camera setting. 	

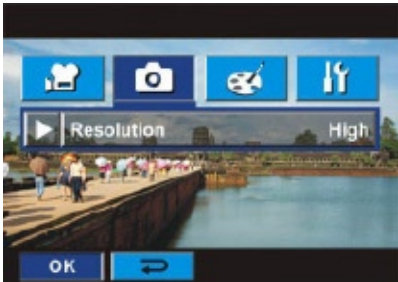
Picture Resolution

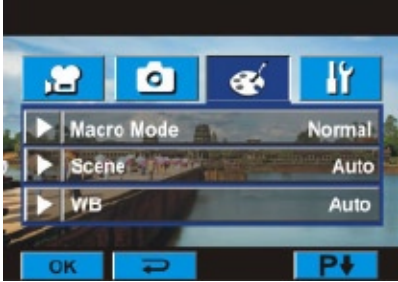

Operation	Display Screen
<ol style="list-style-type: none"> In Picture Mode submenu, touch [Resolution] on the screen. Touch  on the screen to move between three settings. Touch OK icon to validate the setting then touch exit icon () to back to Record mode. 	

Effect Submenu Setting

Operation	Display Screen
<ol style="list-style-type: none"> 1. In Record Mode, touch  (on-screen icon) to enter record menu screen. 2. Touch [Effect] icon on the screen. Submenu of Effect will pop out on the screen. 3. The Effect submenu contains 4 options--Macro Mode, Scene, WB, and ISO--for you to adjust the camera setting. 4. Touch  /  on the screen to change the page. 	

Macro Mode

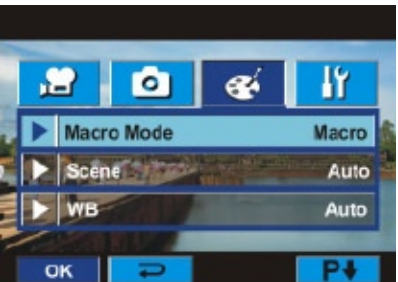

With Macro Mode set to Macro, you could take closer movies/images of objects in distance of 1cm to 80cm.

Operation	Display Screen
<ol style="list-style-type: none"> 1. In Effect submenu, touch [Macro Mode] on the screen. 2. Touch  on the screen to choose Macro or Normal. 3. Touch OK icon to validate the setting then touch exit icon () to back to Record mode. 	

Scene

You can select the mode according to the scene condition.

- **Auto:** Shoot without any special effect on the image.
- **Skin:** Shoot with an effect that makes skin tones more natural.
- **Night:** Use Night mode for night scenes or low light conditions.
- **Backlight:** You can take shots when bright light is behind the subject.
- **B/W:** The image is converted to black-and-white.
- **Classic:** The image is converted to sepia look is applied to the image.
- **Negative:** The image is converted as the negative of the normal

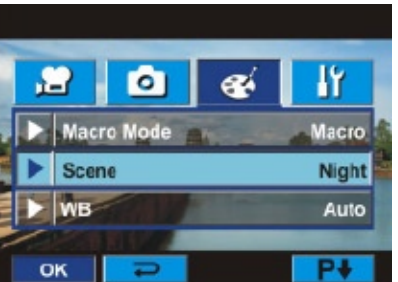
Operation	Display Screen
<ol style="list-style-type: none"> 1. In Effect submenu, touch [Scene] on the screen. 2. Touch  on the screen to move between 7 settings. 3. Touch OK icon to validate the setting then touch exit icon () to back to Record mode. 	





Note

To avoid blurry pictures, place the camera on a flat, steady surface, or use a tripod when take shots in Night mode.

WB (White Balance)

The camera adjusts the color balance of images automatically. Three manual white balance settings are available:

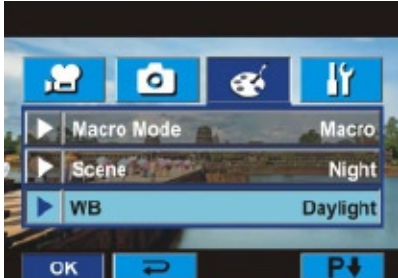

- **Auto:** The camera automatically adjusts white balance.
- **Daylight:** Under outdoors.
- **Fluorescent:** Under fluorescent light condition.
- **Tungsten:** Under tungsten light condition.

Operation	Display Screen
<ol style="list-style-type: none"> 1. In Effect submenu, touch [WB] on the screen. 2. Touch  on the screen to move between 4 settings. The change can be previewed immediately. 3. Touch OK icon to validate the setting then touch exit icon () to back to Record mode. 	

ISO

The camera adjust the ISO sensitivity of images automatically. Two manual ISO sensitivity settings are available. The larger the number, the higher the sensitivity.

- **Auto:** The camera automatically adjusts ISO sensitivity.
- **ISO 800**
- **ISO 1600**



Operation	Display Screen
<ol style="list-style-type: none"> 1. In Effect submenu, touch [ISO] on the screen. 2. Touch  on the screen to move between three settings. 3. Touch OK icon to validate the setting then touch exit icon () to back to Record mode. 	

Section 4

Enjoying the Playback Mode

Button Function

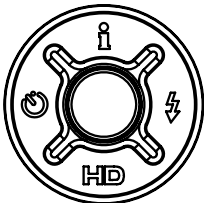
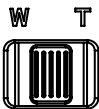
The Buttons have the following functions in Movie and Picture Playback Modes.



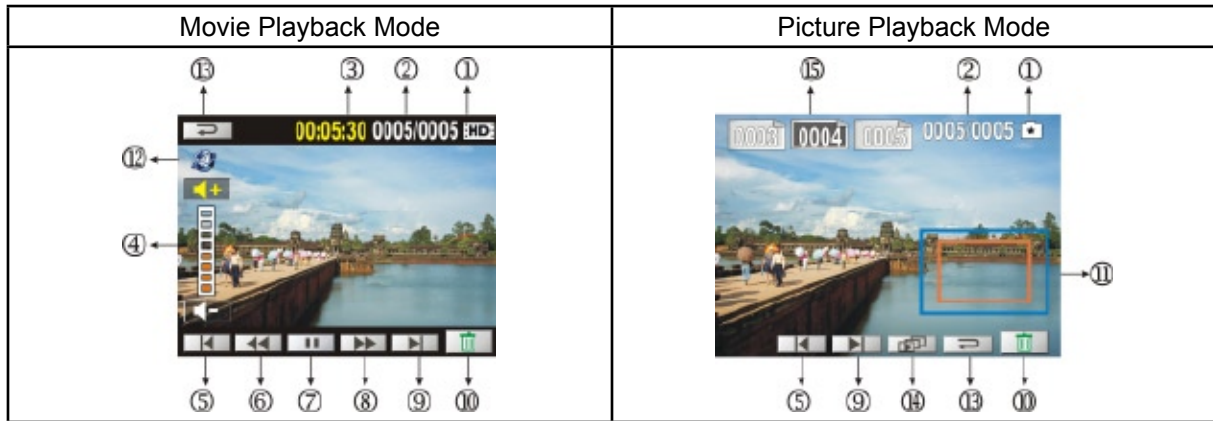

 	<p>Direction Button</p> <p>Right Button: Go to the next movie/picture. Fast forward.</p> <p>Left Button: Go to the previous movie/picture. Fast rewind.</p> <p>Up Button: Volume increase. Information ON/OFF.</p> <p>Down Button: Volume decrease. Delete the current or all movies/pictures.</p> <p>Menu/OK Button:</p> <ol style="list-style-type: none"> 1. Validate the setting. 2. In Movie Playback Mode, press to select the current movies to upload to YouTube. 3. In Picture Playback Mode, press to start slideshow. 4. In Picture Magnification Mode, press to exit to Picture Playback Mode. <p>Tele Button : Magnification mode On. Zoom in.</p> <p>Wide Button : Magnification mode Off. Zoom out</p>
	<p>RECORD/PLAY Button functions:</p> <ol style="list-style-type: none"> 1. Switch between Record and Playback modes. 2. Return to the previous page.
	<p>Movie Shutter Button:</p> <p>Start playing the recorded movie.</p>

LCD Monitor Information

Indicators on the LCD screen while in Playback Mode:



(1)		HD (1080p) (30fps)
		HD (720p) (30fps)
		WVGA (60fps)
		VGA (30fps)
		QVGA (30fps)
		High
		Standard
		Low
(2)	0005/0005	Current number/ Total number of movie.
(3)	00:06:10	Movie playback time counter
(4)		Volume
(5)		Previous movie/picture
(6)		Movies fast rewind
(7)		Movies play
		Movies pause
(8)		Movies fast forward
(9)		Next movies/ picture
(10)		Delete
(11)		Magnification Indicator.







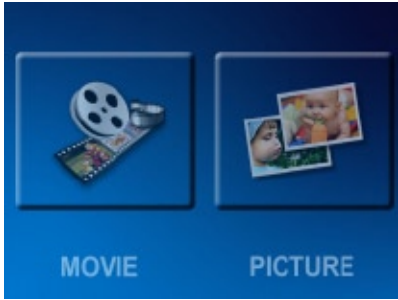

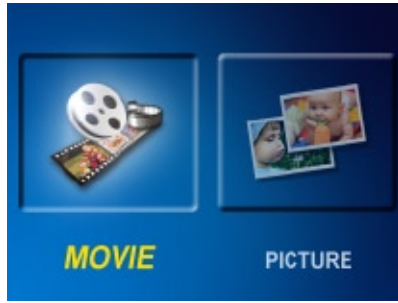

(12)		Movies is selected to upload to YouTube
(13)		Exit
(14)		Slideshow
		Slideshow stop
(15)		Consecutive number of picture

Operations for Playback Mode

The Playback Mode is for viewing and managing movies and pictures on the built-in memory or on an SD card.

Operation	Display Screen
<ol style="list-style-type: none"> 1. Press RECORD/PLAY Button () to switch from Record Mode to Playback Mode Main Menu. There are 2 options in the Playback Mode, Movie and Picture. 2. Touch to select the specific option. 	

Movie Playback







Operation	Display Screen
<ol style="list-style-type: none"> 1. Touch [Movie] on the screen to enter Movie Playback Mode. 	
<ol style="list-style-type: none"> 2. Touch  to play or pause the movies. 3. Sweep to the left or touch  to go to the previous movie; sweep to the right or touch  to go to the next movie. 4. While playing movies, touch  /  to fast rewind/forward. 5. Touch  to increase the volume; touch  to reduce the volume. 6. Touch exit icon () to exit. 7. Press Menu/OK button to select the current movies to upload to YouTube. 	



Note

When the LCD is idle for few seconds, the playback function bars will disappear automatically.

Delete Movies







Operation	Display Screen
<p>1. Touch  to go to the Delete option screen.</p>	
<p>2. Touch  /  to select the movies.</p> <p>3. Touch [Yes] to delete the current movies or [No] to cancel the operation and exit; touch [All] to delete all movies.</p> <p>4. Before all movies are deleted, a confirmation screen will appear; touch [Yes] to execute the operation and [No] to cancel the operation.</p>	 



Note

- If a memory card is inserted, you can delete only those movies stored on the card.
- Movies on a written-protected memory card cannot be deleted.

Picture Playback

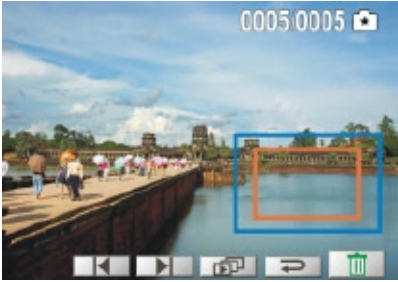



Operation	Display Screen
<p>1. Touch [Picture] on the screen to enter Picture Playback Mode.</p>	
<p>2. Sweep to the left or touch  to go to the previous picture; sweep to the right or touch  to go to the next picture.</p> <p>3. While the picture is selected, press on the screen as well as go up to enter Magnification Mode. In the Magnification Mode, press on the screen as well as go up to zoom in or go down to zoom out.</p> <p>4. To navigate the magnified picture, press on the screen as well as move (The inner Magnification Indicator turns red). Press Menu/OK Button to exit navigation mode.</p> <p>5. Touch  /  to start or stop the slide show.</p> <p>6. Touch exit icon () to exit.</p>	



Note

When the LCD is idle for few seconds, the sildeshow function bars will disappear automatically.

Delete Picture

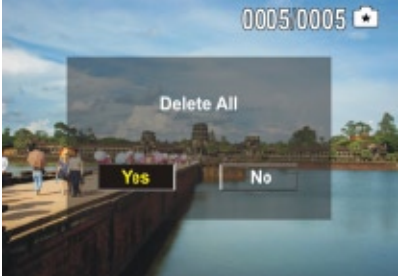
Operation	Display Screen
<p>1. Touch  to go to the Delete option screen.</p>	
<p>2. Touch  /  to select the picture.</p> <p>3. Touch [Yes] to delete the current picture or [No] to cancel the operation and exit; touch [All] to delete all pictures.</p> <p>4. Before all pictures are deleted, a confirmation screen will appear; touch [Yes] to execute the operation and [No] to cancel the operation.</p>	 





Note

- If a memory card is inserted, you can delete only those pictures stored on the card.
- Pictures on a written-protected memory card cannot be deleted.

Section 5

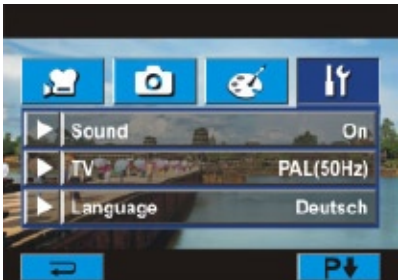

Setting Your Camera

Setting Menu

Operation	Display Screen
<ol style="list-style-type: none"> 1. In Record Mode, Press  (on-screen icon) to enter record menu screen. 2. Touch [Setting] icon on the screen. Submenu of Setting will pop out on the screen. 3. The Setting submenu contains 6 options for configuring your camera set up. They are Sound (operation sound), TV, Language, Format, Time Setting, and Default Setting. 4. Touch  /  on the screen to change the page. 	

Sound

Enable or disable KeyPad tone and operation sound.

Operation	Display Screen
<ol style="list-style-type: none"> 1. In Setting submenu, touch [Sound] on the screen. 2. Touch  on the screen to choose On or Off. 3. Touch OK icon to validate the setting then touch exit icon () to back to Record mode. 	



TV

Ensure that the appropriate TV standard of your area is selected – either NTSC or PAL.

Wrong TV system setting may cause image flicker.



NTSC standard: USA, Canada, Japan, South Korea and Taiwan etc.

PAL standard: UK, Europe, China, Australia, Singapore and Hong Kong etc.

Operation	Display Screen
<ol style="list-style-type: none">1. In Setting submenu, touch [TV] on the screen.2. Touch  on the screen to choose NTSC(60Hz) or PAL(50Hz).3. Touch OK icon to validate the setting then touch exit icon () to back to Record mode.	 A screenshot of a camera's settings menu. At the top, there are four icons: a camera, a camera with a flash, a globe, and a wrench. Below these are three menu items: 'Sound' with 'Off' to its right, 'TV' with 'NTSC(60Hz)' to its right, and 'Language' with 'Deutsch' to its right. At the bottom, there are three buttons: 'OK', a right arrow, and a 'P+' button.

Language

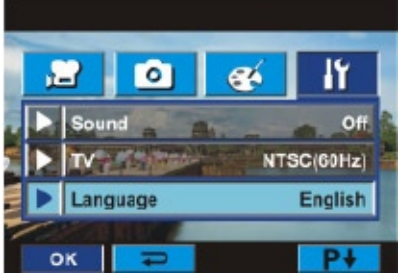

Use this option to select the language of user interface which you want.

Operation	Display Screen
<ol style="list-style-type: none">1. In Setting submenu, touch [Language] on the screen.2. Touch  on the screen to choose the language options.3. Touch OK icon to validate the setting then touch exit icon () to back to Record mode.	 A screenshot of a camera's settings menu, similar to the one above. The 'Language' option is now highlighted in blue, and its value is 'English'. The 'TV' option is still set to 'NTSC(60Hz)'. The 'Sound' option is 'Off'. The bottom buttons are 'OK', a right arrow, and 'P+'.

Format

Yes: Format the built-in memory (When there is no SD card in the camera) / SD Card (When there is an SD card in the camera).

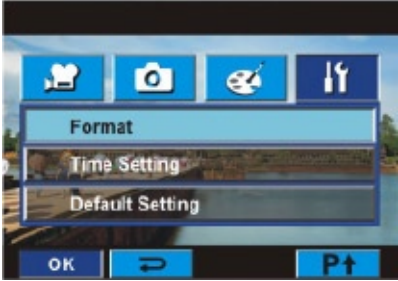
No: Do not format the built-in memory (When there is no SD card in the camera) / SD Card (When there is an SD card in the camera).

Operation	Display Screen
1. In Setting submenu, touch [Format] on the screen to go to the format confirmation screen.	
2. Touch [Yes] to execute the operation and [No] to cancel the operation.	



Note

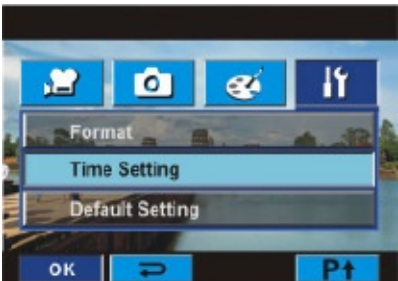
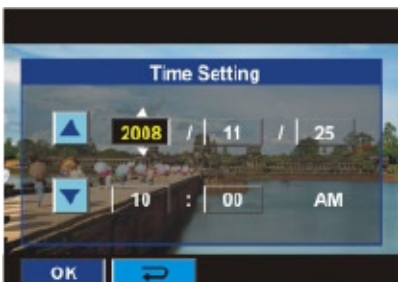

All the data will be erased if the SD card is formatted. Make sure all the data are backup to PC before formatting SD card.

Time Setting

Operation	Display Screen
1. In Setting submenu, touch [Time Setting] on the screen to go to the Time Setting menu.	
2. Touch Year, Month, Day, Hour, or Minute to be set. 3. Adjust the numeric value by touching ▲ / ▼ . 4. Touch OK icon to validate the setting then touch exit icon (↵) to back to Record mode.	

Default Setting

To restore the default factory setting, select this option.

Operation	Display Screen
1. In Setting submenu, touch [Default Setting] on the screen to go to the Default Setting confirmation screen.	
2. Touch [Yes] to execute the operation and [No] to cancel the operation.	

The following table indicates the camera's default setting

Setting	Default Factory Setting
Resolution	HD (1080p) for Movie Standard for Picture
Stabilization	Off
Motion Detect	Off
Macro Mode	Off
Scene	Auto
WB (White Balance)	Auto
ISO	Auto
Sound	On
TV	Depends on shipping area
Language	Depends on shipping area
Volume	Level 7
Flash	Off
Self-timer	Off

Section 6

Viewing Pictures and Movies on a TV

Connecting to a High-Definition 16:9(Wide) TV

1. Connect one end of the HDMI cable to your camera's HDMI out port.
2. Connect the other end of the cable to a television.
3. Set video input source of a TV to "HDMI" option.
4. Use direction button to view stored pictures and movie on a TV.
 1. Use Right/Left Buttons to go to the next or last movie/picture.
 2. Press Movie Shutter Button to play movies and press it again to pause.
 3. While playing movies, press Right/Left Buttons to fast forward/rewind, then release the button to stop.
 4. Use Up/Down Buttons to adjust volume.
 5. In Picture Playback mode, use Tele Button to magnify the picture. To navigate the magnified picture, use Direction Buttons to navigate the magnified picture. Press Menu/OK Button to exit navigation mode.

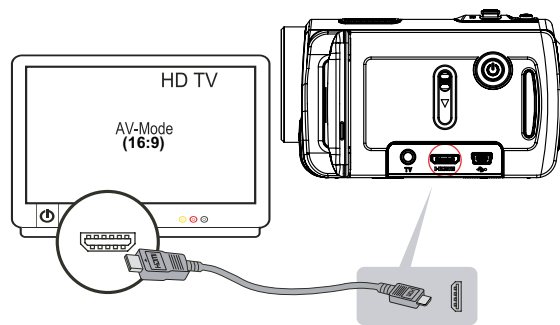

Note

The camera can not run movie recording and picture taking when it is connected to an HDTV. The LCD Panel does not display when the camera is connected to an HDTV.

Connecting to a non-high-definition 4:3 TV

1. Connect one end of the AV cable to your camera's AV out port.
2. Connect the other end of the cable to a television.
3. Use direction button to view stored pictures and movie on a TV.

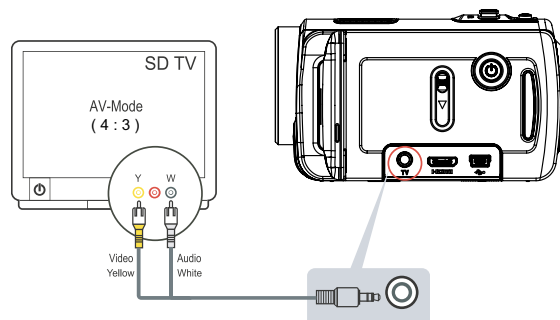

Note

The LCD Panel does not display when the camera is connected to a TV.

Section 7

Viewing Movie & Picture on PC

Installing Bundled Software

The CD-ROM supplied with this camera contains 2 pieces of software.

- **ArcSoft MediaImpression** is a user-friendly application that helps you managing your media, burning your video into DVD, and uploading your videos to YouTube easily.
- **Adobe Reader** is a popular program that you need to have installed to read the User's Manual. Many computer users will find they already have this software installed on their computer.

To install the bundled software:

1. Insert the CD-ROM into your computer's CD-ROM drive. The autorun screen appears.
2. Click "**Install ArcSoft MediaImpression**". Follow the on-screen instructions to complete the installation.



Note

The detailed information can be found in online help of all the bundled software.

Transferring Pictures or Movies to a Computer

You can transfer pictures or movies stored on your camera to a computer and send them in emails to friends or post them on websites.

To do this you should:

1. Connect the computer and camera with the supplied mini USB 2.0 cable. The LED will light up and blink.
2. After the LED stops blinking, movies and picture(s) can be found on your computer at "My Computer\Removable Disk\DCIM\100MEDIA".
3. Under this folder, you can view, delete, move, or copy any movie/picture you want.
4. Use the bundled ArcSoft application software to edit the movies or pictures.

Section 8

Burning the Recorded Clip into DVD

Bundled software CD contains ArcSoft MediaImpression features burning the movie clip into DVD. You can share this DVD movie with family and friends by using regular DVD player.

To create a DVD:

1. Install ArcSoft MediaImpression (Refer to Section 7).
2. Click Windows [Start] → [(All) Programs] → [ArcSoft MediaImpression].
3. ArcSoft MediaImpression main Screen will appear on your desktop.
4. Click [Make Movie] .



5. The operation screen will appear:

- Select the folder that contains the video files you want to burn.
- Select the file(s).
- Click button to add the files into slide.
- Click [Burn to Disc].

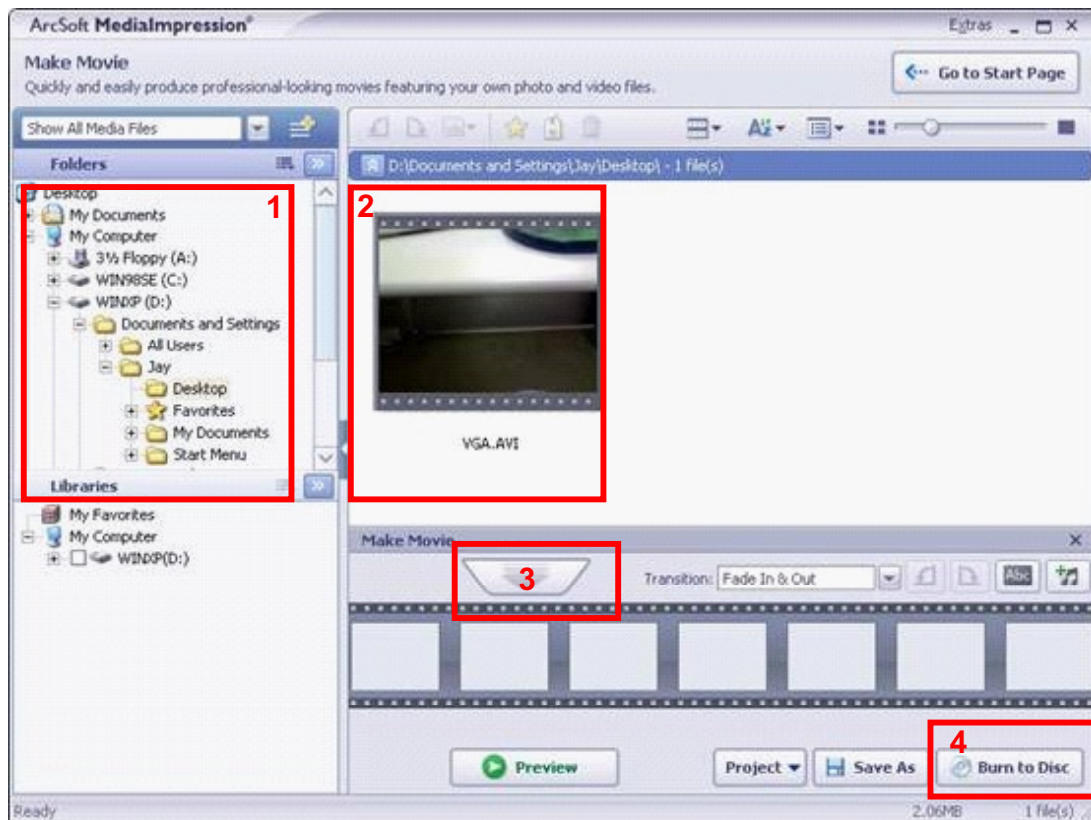

6. Click [Start] to start DVD burning.



Section 9

Uploading Video Files to YouTube

The built-in **YouTube Direct** application offers you an easy way to upload your video clips to YouTube instantly. It helps you share them with your family and friends on YouTube website.

To upload video files to YouTube:

1. Select the video clips in Movie Playback Mode by pressing Menu/OK Button .
2. Connect the camera and computer with the supplied USB cable.

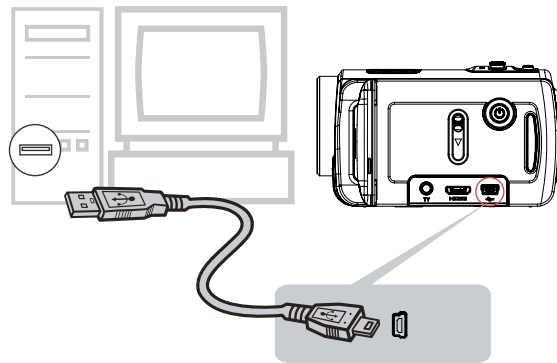

3. After making a USB connection, the auto-run screen will appear. Click [YouTube Direct]→ [OK] as the main screen appears automatically on the desktop.



Note

If the auto-run screen does not appear. Click [My Computer]→[DV(X:)]→[dvap.exe] to execute the application.

- Preview the video: double click on the video clip in thumbnail screen. Click Play/Pause icon to play/pause. Click Return icon to back to thumbnail preview screen.



5. Upload video clip

- Upload single video clip or selected video clips: In thumbnail screen, click up/down icon to change the pages. Click on the video clip you want to upload (+ Ctrl Button to select two or more video clips), and then click [Upload selected videos to youtube] icon.

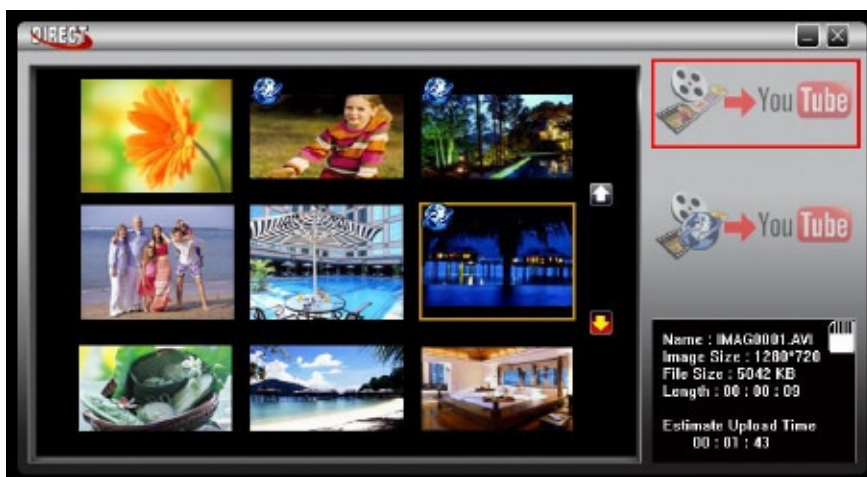

- Upload the video clips which are selected in the camera earlier: Click [Upload DV-selected videos to youtube] icon.

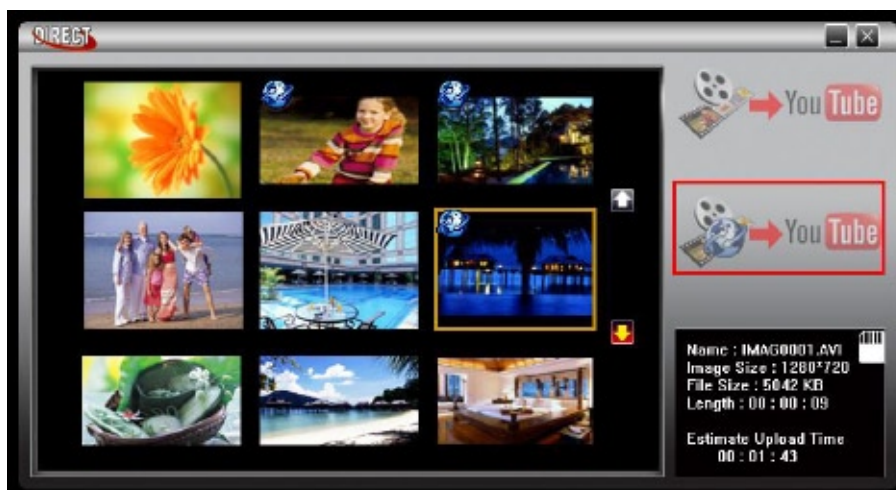

6. Fill in the information in the blanks.

The screenshot shows the 'YouTube Link' application window. It is divided into three main sections: 'User Info', 'Upload Info', and 'File Info'.
- **User Info:** Contains 'User Name' (test1) and 'Password' (*****). Buttons for 'SignUp' and 'Save User Info.' are on the right.
- **Upload Info:** Shows 'Total-Upload: 1/1' and a dropdown menu with 'IMAG0004.AVI'. A thumbnail of a flower is displayed to the right.
- **File Info:** Contains 'Title' (IMAG0004.AVI), 'Description' (20090123 21:06:01), 'tags' (MyDV), 'Video Category' (Autos & Vehicles), and 'Broadcast Option' (Public selected, Private unselected).
At the bottom, there is an 'Upload Videos...' button, an 'Exit' button, and a note: 'click "Upload Videos..." to start upload file'.

7. If you do not have a YouTube account, click [SignUp] to register a new YouTube account firstly. Then, the YouTube sign-up screen will appear. Please follow the instruction on YouTube website. If you want to save the user's name and password, click [Save User Info].

This screenshot is identical to the previous one, but with a red rectangular box highlighting the 'SignUp' and 'Save User Info.' buttons in the 'User Info' section.

8. Click [Upload Videos] to upload the video(s).

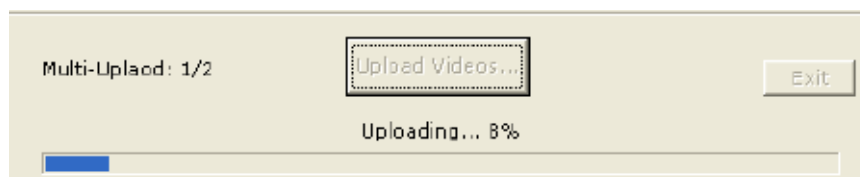
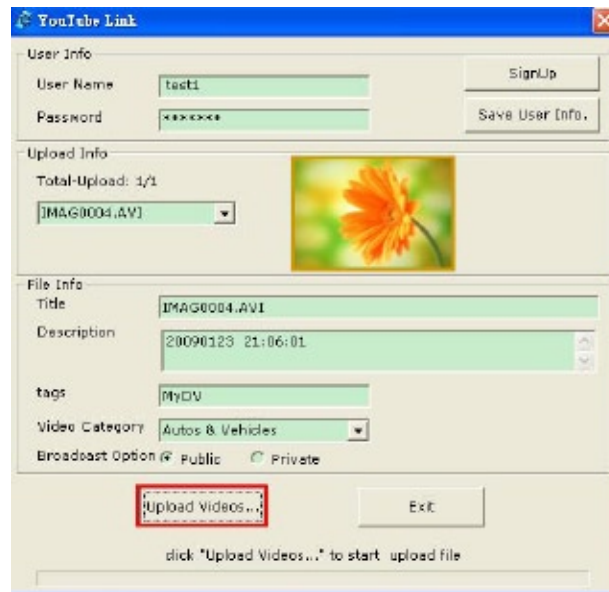

Section 10

Specifications and System Requirements

Specification	
Image sensor	5 Mega pixel CMOS sensor
Operation modes	Movie record, Picture record
Lens	f=6.8 ~ 34mm; F3.5 ~3.7
Focus range	10cm~infinite (Normal mode) 1cm~80cm (Macro mode)
Zoom	HD(1080p):1X~5X (5X Optical zoom and 1X Digital zoom) Other video resolution:1X~20X (5X Optical zoom and 4X Digital zoom)
Shutter	Electronic
LCD monitor	3" touch LCD
Storage media	Built-in 128MB memory (partial memory is used for firmware code); SD/SDHC card slot support (up to 32GB)
Image resolution	High 4000x3000 (12M pixels) Std 2592x1944 (5M pixels) Low 2048x1536 (3M pixels)
Movie resolution	HD(1080p) 1920X1080(30fps) HD(720p) 1280X720(30fps) WVGA 848X480(60fps) VGA 640X480(30fps) QVGA 320X240(30fps)
White balance	Auto/Manual (Daylight, Fluorescent, Tungsten)
ISO	Auto/800/1600
Self-timer	10 seconds delay
Flash	Flash Auto/Red-Eye-Reduction/Digital Light/Flash Off
File format	Picture: JPG Movie: AVI
Image play	Single image/Slideshow
PC interface	Mini USB 2.0 port
TV out	NTSC/PAL selectable, HDMI
Battery	Lithium-ion rechargeable battery
Dimension	112(H) * 52(W) * 65(D) mm
Weight	320 g (without battery)

System requirements

- Microsoft Windows 2000/XP/Vista
- Intel Pentium III 800MHz or above
- 256 MB RAM
- CD-ROM Drive
- 700 MB free HDD space
- Available USB port
- 16-bit Color Display



Note

The LCD screen is manufactured using extremely high-precision technology so over 99.99% of the pixels are operational for effective use. However, some tiny black and/or bright dots (white, red, blue or green) may appear on the LCD screen. These dots are a normal result of the manufacturing process, and do not affect the recording.

Section 11

Troubleshooting

Troubleshooting

1. If the LCD image is not clear when shooting, how can the focus be adjusted?

Try to switch between Macro and Normal Mode. (Macro Mode: For object in distance about 1cm to 80cm, Normal Mode: For object in distance beyond 10cm)

2. The flash is not working.

The battery power is low.

3. The files on the memory card do not display smoothly when the LCD shows the “!” marking.

The “!” means the SD card is low speed or having wrong content inside. The way to solve this condition is to format SD card by camera instead of PC (Please refer to the detailed Format instruction in Section 5).

4. Why is camera flash not active when taking pictures?

In flash auto mode, camera flash fires ONLY when necessary (in dark setting as example).

5. Why do some of my indoor pictures look blurry and dark?

Camera extends pictures exposure time under low light/ indoor condition. Keep camera (and photographed subject) steady for several seconds when taking pictures. Shutter will sound when picture has been taken.

6. How do I charge battery?

You must use the supplied AC charger or USB cable.

Camera must be turned OFF; blinking light confirms charging, but light is constant when charging has been completed.